

EMERGENCY EXIT DEVICES ACCORDING TO EN 179

The following locks and handles are approved to be installed together in an emergency exit door to conform EN 179.

Profile door locks	IKON DO 20.15.02	FSB DO 20.03.01, DO 20.03.02	HEWI DO 20.13.01, DO 20.13.02
EL460 EL462	e.g. S6B3, S6B6	1016, 1023, 1052, 1056, 1070, 1080, 1088, 1090, 1117, 1118, 1119, 1137, 1146, 1155, 1160, 1161, 1162, 1177, 1178, 1191, 0612, 0616, 0617, 0619, 0625, 0627, 0628, 0646, 0662, 0665, 0680, 0681, 0682, 0688	111, 111.23, 114.23GK, 131, 132, 111X, 113X, 114X, 161X, 163X, 171X, 112X, 165X, 166X
EL260 EL262 EL060 EL062	e.g. S6B8		
Wooden and metal door locks	IKON DO 20.15.02		
EL560 EL562	e.g. S326, S426, S4K3		
EL360 EL362 EL160 EL162	e.g. S4K6		

The safety features of this product are essential to its compliance with EN 179. No modification of any kind, other than those described in the installation manual, are permitted.

PANIC EXIT DEVICES INSTALLATION ACCORDING TO EN 1125

The following locks and push bars are approved to be installed together in a panic exit door to conform EN 1125. The push bars can be installed for example with above mentioned outside fittings (Table EN 179) to conform EN 1125.

Profile door locks	effeff DO 30.04	JPM DO 30.05
EL460 EL260 EL060	8000-00-1100 (-), 8000-10-1100 (PZ)	
EL462 EL262 EL062		
Wooden and metal door locks	effeff DO 30.04	NORMA 870000-30-0A NORMA 870000-31-0A NORMA 870000-32-0A NORMA 870000-33-0A
EL560 EL360 EL160	8000-00-1100 (-), 8000-20-1100 (PZ)	
EL562 EL362 EL162		

The safety features of this product are essential to its compliance with EN 1125. No modification of any kind, other than those described in the installation manual, are permitted.

This document may not be used in the installation of a lock. Drilling and wiring diagrams and installation instructions are included in the installation manual, which is included in each lock case package.

We reserve the right to make alterations to the products described in this leaflet.



Abloy Oy
Wahlforsinkatu 20
P.O. Box 108
FIN-808101 JOENSUU
FINLAND
Tel. +358 13 2501
Fax +358 13 250 2209



www.abloy.com

952228

ABLOY® EL460, EL461, EL560, EL561 - Europrofile handle controlled locks

ABLOY® EL460, EL461

ABLOY® EL560, EL561

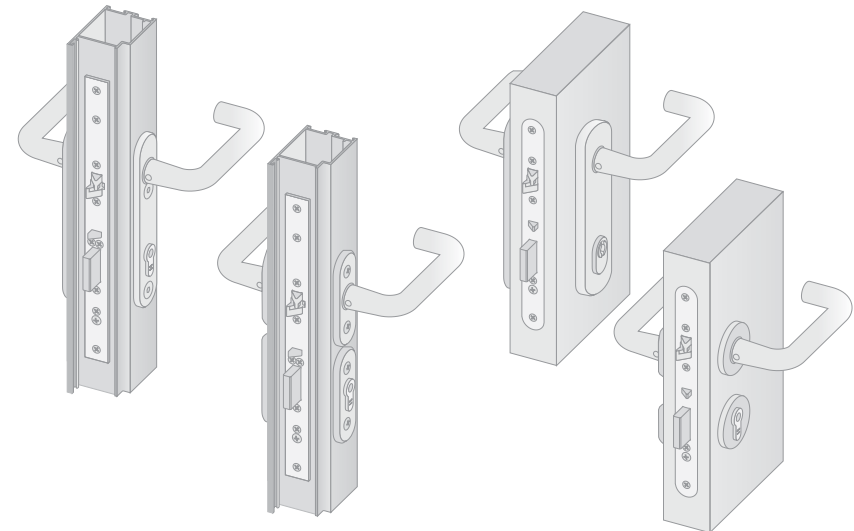

New Europrofile locks can be installed with long plates or roses.

FUNCTION

Handle controlled locks can be set to function as fail locked or as fail unlocked. In the fail locked setting, the lock can be opened by handle, when power is on, and it can not be opened by handle, when power is off. In the fail unlocked setting, the electrical function is the opposite.

ABLOY® EL560 and ABLOY® EL460

Only outside handle is electrically controlled. The lock can always be opened by inside handle. Mechanical opening by cylinder is always possible.

ABLOY® EL561 and ABLOY® EL461

Both inside and outside handles are electrically controlled. Mechanical opening by cylinder or thumbturn is always possible.

APPLICATION

The locks are recommended to be used in the interior doors of business premises, public buildings, hospitals, educational premises etc. Typical applications are the doors of:

- offices
- meeting rooms
- storage rooms
- technical maintenance rooms
- consulting rooms
- fire doors (medium traffic)

EL560 and EL561 are used in wooden and metal doors. EL460 and EL461 are used in narrow profile doors. EL560 or EL460 with split spindle is chosen, when exit by handle is needed. EL561 or EL461 is chosen, when both access and exit are electrically controlled.

Handle controlled locks are best suited in medium traffic doors. The locks can be electrically controlled by access control system or by a remote control system such as timer, keypad or push button.

The locks can be used both in exit and fire rated doors (EN). The locks are not suitable to be used with door automatics.

Also available:

- Microswitch locks
EL360 for wooden and metal doors
EL260 for narrow profile doors
- Mechanical locks
EL160 for wooden and metal doors
EL060 for narrow profile doors

Also available lock cases for Swiss cylinder (RZ):

- EL562 (split spindle), EL563 (through spindle) for wooden and metal doors
- EL462 (split spindle), EL463 (through spindle) for narrow profile doors
- EL362 microswitch lock for wooden and metal doors
- EL262 microswitch lock for narrow profile doors
- EL162 mechanical lock for wooden and metal doors
- EL062 mechanical lock for narrow profile doors

STANDARD DELIVERY

Lock case is delivered as Fail locked and its opening direction (handing) is 4 (split spindle) or 2.4 (other models).

Standard delivery includes:

- Lock case
- Fixing screws etc.
- Spindle adapters
- Installation manual

Please specify when ordering:

- Lock type
- Backset, Forend
- Opening direction to select strike plate

OPENING DIRECTIONS (HANDINGS)

	ABLOY	DIN
①	Right inwards	Left inwards
②	Left inwards	Right inwards
③	Left outwards	Left outwards
④	Right outwards	Right outwards

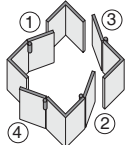

DIMENSIONS

ABLOY® EL460, EL461

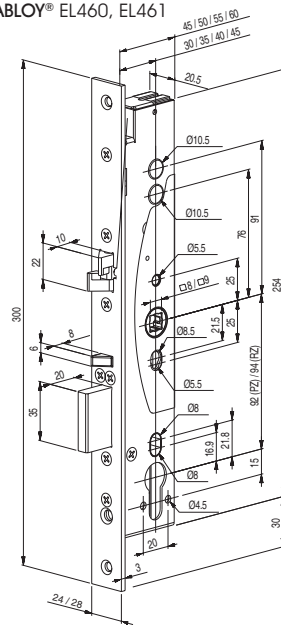

ABLOY® EL560, EL561

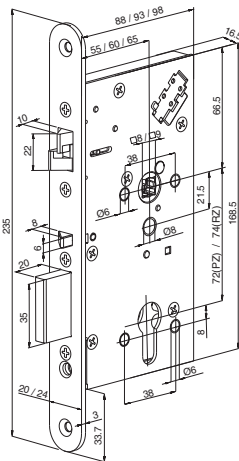

STANDARDS

EN STANDARDS	
EN 179:2003	Exit
EN 1125	Panic exit
EN 1634-1	Fire resistance
EN 61000-6-1:2001	EMC
EN 61000-6-3:2001	EMC

pREN STANDARDS (under testing)	
pREN 12209	Mechanical resistance
pREN 1627	Burglary resistance

LOCAL STANDARDS (under testing)	
NEN 5089:1995	SKG, mechanical strength and burglary resistance
GOST-R	

TECHNICAL DETAILS

Operating voltage:	12 - 24 V DC STAB (-10%, +15%)
Current:	Max. 0.4 A (12V DC), 0.17 A (24V DC), less than a second Idle 0.13 A (12V DC), 0.065 A (24V DC)
Micro switches:	Max. 0.5 A 30 V AC/DC resist, 10 W
Operating temperature:	-20°C - +60°C
Bolt throw:	20 mm (deadbolt), 10 mm (double action bolt)
Backset:	55, 60, 65 mm (EL560, EL561) 30, 35, 40, 45 mm (EL460, EL461)
Forend:	20, 24 mm (EL560, EL561) 24, 28 mm (EL460, EL461)
Spindle:	9 mm (8 mm with spindle adapters)
Settable functions:	Mechanical functions: - Handing of trigger bolt - Electrically controlled side (EL560, EL460)
	Electrical function: Fail locked / Fail unlocked
Monitoring outputs:	Bolt deadlocked Bolt inside the lock case Trigger bolt in Handle used Cylinder used Cable sabotage

CONTROL PRINCIPLE AND AVAILABLE MONITORING OUTPUTS

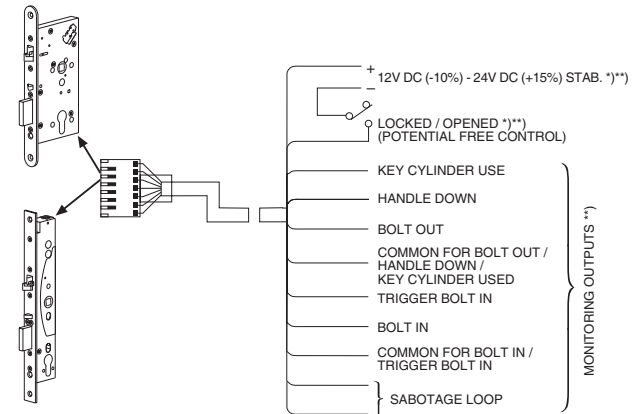

**)*)* Not microswitch or mechanical locks
**)*)* Not mechanical locks

DOOR ENVIRONMENT

Wooden and metal doors

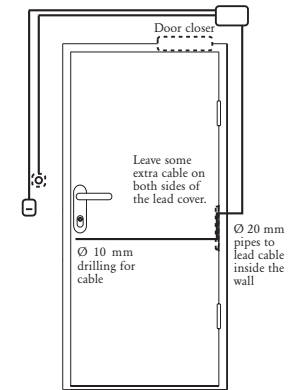

Narrow profile doors

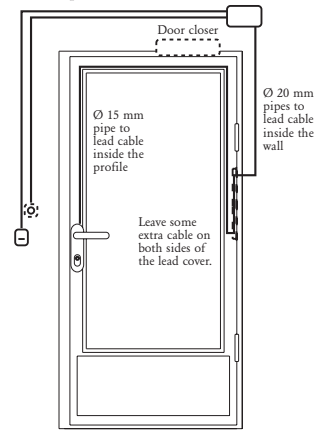

CAM ANGLE

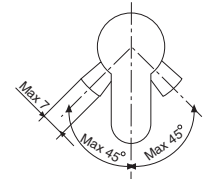

COMPATIBILITY CHART FOR CYLINDERS, FITTINGS AND ACCESSORIES

	EUROPROFILE DIN CYLINDERS		FITTINGS	ACCESSORIES (please order separately)		
	ABLOY PROTEC	ABLOY DISKLOCK PRO		CABLES	LEAD COVERS	STRIKE PLATE
Single	CY303N, CY313N CY307N, CY317N	CY303D	IKON Ruko BEZAULT ABLOY*) others	EA218 (6m) EA219(10m)	EA280 EA281	EA321**)*) EA322 EA323**)*) EA324
Double	CY304N, CY314N CY308N, CY318N	CY304D				
Single with thumbturn	CY305N, CY315N CY309N, CY319N	CY305D				

**)*)* For further information, please contact Abloy Oy Tampere factory.
**)*)* Handing must be defined.

Please, notice, that the split spindle is not included in the lock case package.